

E	一般公差:GENERAL TOLERANCE		更改說明:REV.DESCRPTION			更改說明:REV.DESCRPTION	
	尺寸範圍DIM		△			△	
	.0	±0.30	△			△	
	.00	±0.20	△			△	
	.000	±0.10	核准APPD	朱小华	2009-2-18	模型:	料號: ITEM NO
	文件編號		審核CHD			MODEL	A2544TOP-00
	SC-A-2500T		繪圖DWN	LIAOZTING	2009-2-18		
	比例: SCALE					規格: SPEC 2.54 mm Crimp Style Connector	

1

2

3

4

版本REV

繪制日期

A

2009-3-27

A

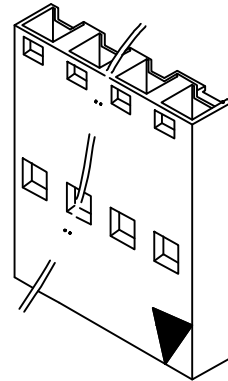
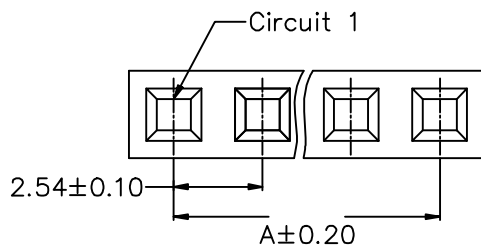

B

C

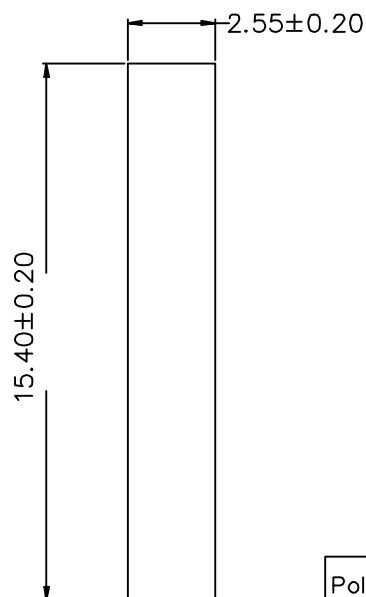
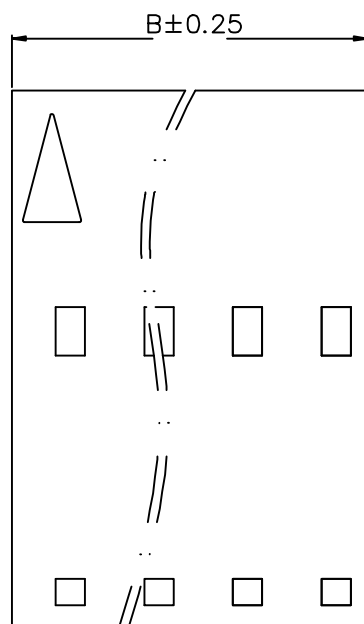

Poles	Dimensions (mm)	
	A	B
2	2.54	5.15
3	5.08	7.69
4	7.62	10.23
5	10.16	12.77
6	12.70	15.31
7	15.24	17.85
8	17.78	20.39
9	20.32	22.93
10	22.86	25.47
11	25.40	28.01
12	27.94	30.55
13	30.48	33.09
14	33.02	35.63
15	35.56	38.18

D

NOTE:

- Material: PA66 94V-0
- Row No.-Pin No.: NP-2P~15P

E

一般公差: GENERAL TOLERANCE

更改說明: REV. DESCRIPTION

更改說明: REV. DESCRIPTION

尺寸範圍DIM

①

④

10.01以上之尺寸

±0.20

②

⑤

10.00以內之尺寸

±0.15

③

⑥

孔位

±0.10

核准APPD

朱小华

2009-3-27

模型:

料號: ITEM NO

文件編號

審核CHD

MODEL

A2544H00-E-NP

SC-EW-11

繪圖DWN

Liaozting

2009-3-27

比例: SCALE



SHIH CHUAN ELECTRONICS

規格: SPEC

2.54mm Crimp Style Connectors

1

2

3

4

版本REV

繪制日期

A

2009-3-27

A

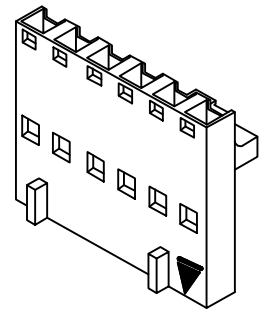
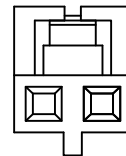
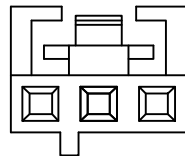
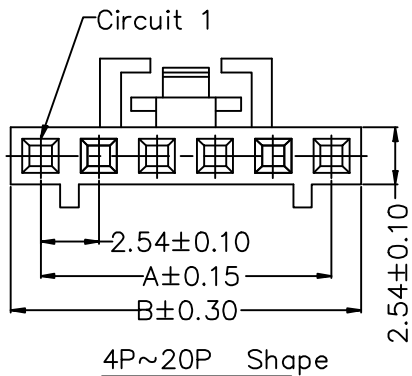

B

C

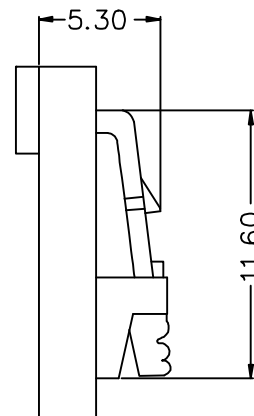
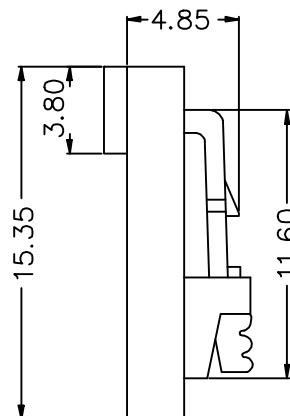
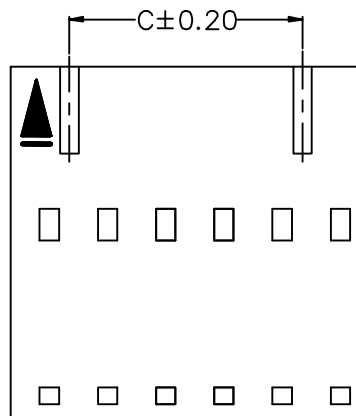

4P~20P

2P~03P

D

NOTE:

- Material: PA66 94V-0
- Row No.-Pin No.: NP-2P~20P

Poles	Dimensions(mm)			Poles	Dimensions(mm)		
	AB		C		AB		C
02	2.54	5.08	--	12	27.94	30.48	25.40
03	5.08	7.62	--	13	30.48	33.02	27.94
04	7.62	10.16	5.08	14	33.02	35.56	30.48
05	10.16	12.70	7.62	15	35.56	38.10	33.02
06	12.70	15.24	10.16	16	38.10	40.64	35.56
07	15.24	17.78	12.70	17	40.64	43.18	38.10
08	17.78	20.32	15.24	18	43.18	45.72	40.64
09	20.32	22.86	17.78	19	45.72	48.26	43.18
10	22.86	25.40	20.32	20	48.26	50.80	45.72
11	25.40	27.94	22.86				

E

一般公差: GENERAL TOLERANCE

更改說明: REV. DESCRIPTION

更改說明: REV. DESCRIPTION

尺寸範圍DIM



10.01以上之尺寸

±0.20



10.00以內之尺寸

±0.15



孔位

±0.10

核准APPD

朱小华

2009-3-27

模型:

料號: ITEM NO

文件編號

審核CHD

MODEL

A2544H00-D-NP

SC-EW-11

繪圖DWN

Liaozting

2009-3-27

比例: SCALE



SHIH CHUAN ELECTRONICS

規格: SPEC

2.54mm Crimp Style Connectors

1

2

3

4

版本REV

繪制日期

A

2009-3-27

A

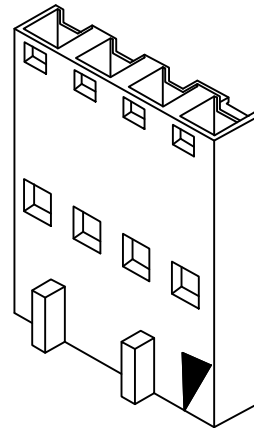
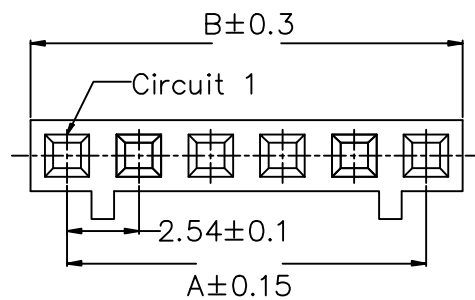

B

C

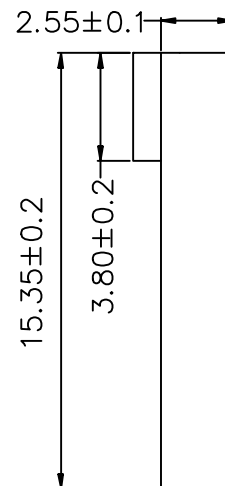
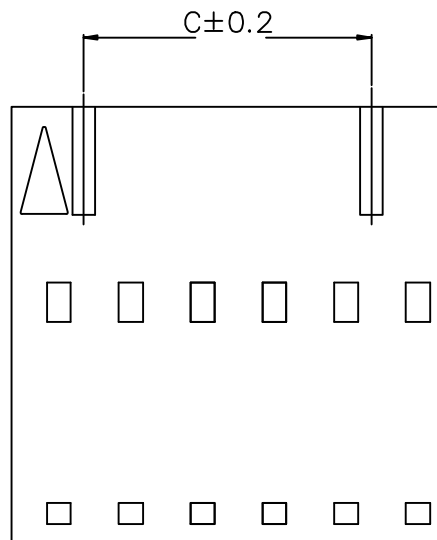

D

NOTE:

- Material: PA66 94V-0
- Row No.-Pin No.: NP-2P~15P

Poles	Dimensions (mm)		
	A	B	C
2	2.54	5.08	--
3	5.08	7.62	2.54
4	7.62	10.16	5.08
5	10.16	12.70	7.62
6	12.70	15.24	10.16
7	15.24	17.78	12.70
8	17.78	20.32	15.24
9	20.32	22.86	17.78
10	22.86	25.40	20.32
11	25.40	27.94	22.86
12	27.94	30.48	25.40
13	30.48	33.02	27.94
14	33.02	35.56	30.48
15	33.02	38.10	33.02

E

一般公差: GENERAL TOLERANCE

更改說明: REV. DESCRIPTION

更改說明: REV. DESCRIPTION

尺寸範圍DIM



10.01以上之尺寸

±0.20



10.00以內之尺寸

±0.15



孔位

±0.10

核准APPD

朱小华

2009-3-27

模型:

料號: ITEM NO

文件編號

審核CHD

MODEL

A2544H00-C-NP

SC-EW-11

繪圖DWN

Liaozting

2009-3-27

比例: SCALE



SHIH CHUAN ELECTRONICS

規格: SPEC

2.54mm Crimp Style Connectors

版本REV	繪制日期
A	2009-3-27

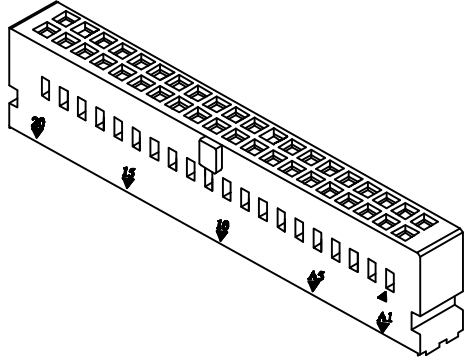
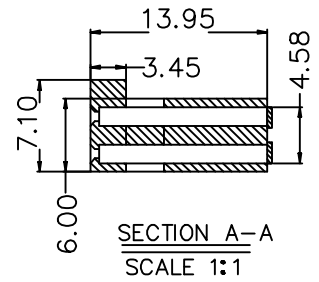
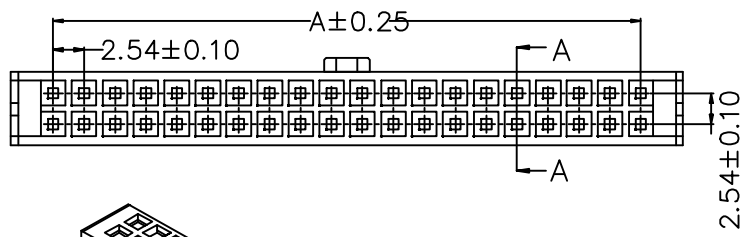
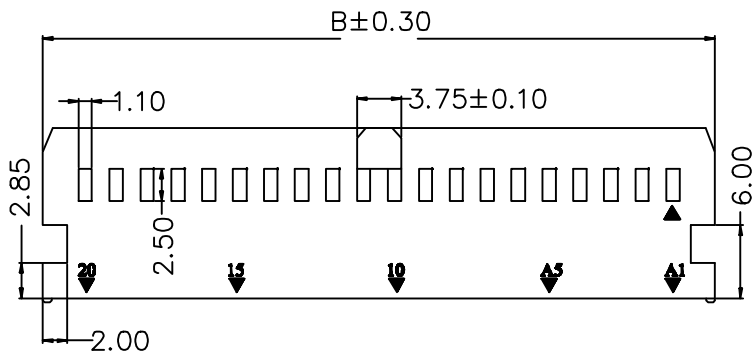

Poles	Dimensions (mm)		Poles	Dimensions (mm)	
	A	B		A	B
4	2.54	9.48	36	43.18	50.12
6	5.08	12.02	38	45.72	52.66
8	7.62	14.56	40	48.26	55.20
10	10.16	17.10	42	50.80	57.74
12	12.70	19.64	44	53.34	60.28
14	15.24	22.18	46	55.88	62.82
16	17.78	24.72	48	58.42	65.36
18	20.32	27.26	50	60.96	67.90
20	22.86	29.80	52	63.50	70.44
22	25.40	32.34	54	66.04	72.98
24	27.94	34.88	56	68.58	75.52
26	30.48	37.42	58	71.12	78.06
28	33.02	39.96	60	73.66	80.06
30	35.56	42.50	62	76.20	83.14
32	38.10	45.04	64	78.74	85.68

NOTE:
 • Material: PBT 94V-0
 • Row No.-Pin No.: NP-02X2P~02X32P

一般公差: GENERAL TOLERANCE		更改說明: REV. DESCRIPTION			更改說明: REV. DESCRIPTION	
尺寸範圍DIM		①			④	
10.01以上之尺寸	±0.20	②			⑤	
10.00以內之尺寸	±0.15	③			⑥	
孔位	±0.10	核准APPD	朱小华	2009-3-27	模型: MODEL	料號: ITEM NO A2544H00-A-2XNP
文件編號 SC-EW-11		審核CHD				
比例: SCALE		繪圖DWN	Liaozting	2009-3-27	規格: SPEC 2.54mm Crimp Style Connectors	



SHIH CHUAN ELECTRONICS

1

2

3

4

版本REV

繪制日期

A

2009-3-27

A

B

C

D

E

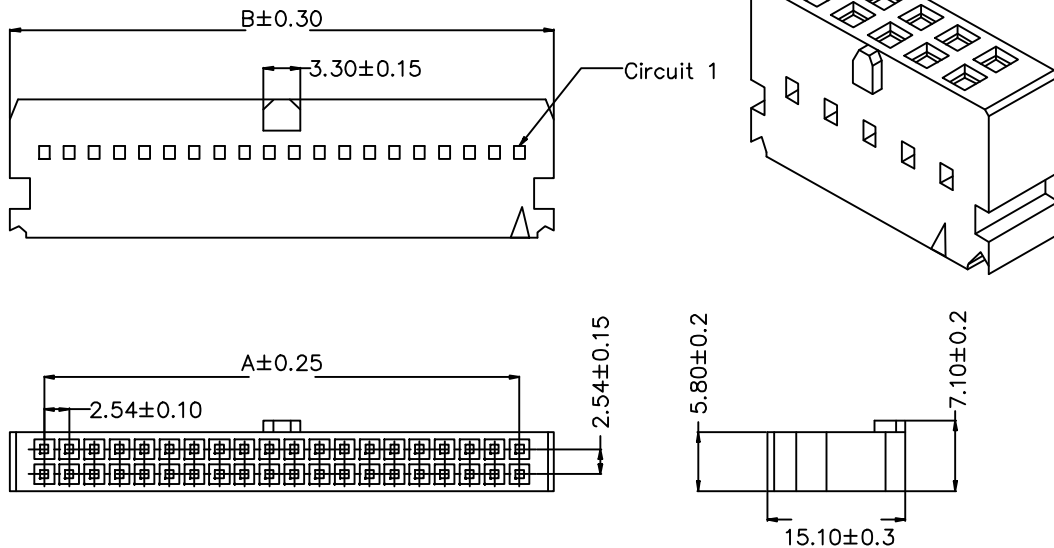

Poles	Dimensions (mm)		Poles	Dimensions (mm)	
	A	B		A	B
4	2.54	9.58	36	43.18	50.22
6	5.08	12.12	38	45.72	52.76
8	7.62	14.66	40	48.26	55.30
10	10.16	17.20	42	50.80	57.84
12	12.70	19.74	44	53.34	60.38
14	15.24	22.28	46	55.88	62.92
16	17.78	24.82	48	58.42	65.46
18	20.32	27.36	50	60.96	68.00
20	22.86	29.90	52	63.50	70.54
22	25.40	32.44	54	66.04	73.08
24	27.94	34.98	56	68.58	75.62
26	30.48	37.52	58	71.12	78.16
28	33.02	40.06	60	73.66	80.70
30	35.56	42.60	62	76.20	83.24
32	38.10	45.14	64	78.74	85.78
34	40.64	47.68			

NOTE:

- Material: PBT 94V-0
- Row No.-Pin No.: NP-02X2P~02X32P

一般公差: GENERAL TOLERANCE

更改說明: REV. DESCRIPTION

更改說明: REV. DESCRIPTION

尺寸範圍DIM



10.01以上之尺寸

±0.20



10.00以內之尺寸

±0.15



孔位

±0.10

核准APPD

朱小华

2009-3-27

模型:

料號: ITEM NO

文件編號

審核CHD

MODEL

A2544H00-2XNP

SC-EW-11

繪圖DWN

Liaozting

2009-3-27

比例: SCALE



SHIH CHUAN ELECTRONICS

規格: SPEC

2.54mm Crimp Style Connectors