

	1	2	3	4		
A				版本REV		
				繪制日期		
B				A		
				2009-2-18		
C						
	<p>NOTE:</p> <p>1.THICKNESS: 0.20mm  2.MATERIAL: Brass  3.FINISH: TIN PIATED  4.APPLICABLE WIRE:AWG22-28  5.使用量具為電子卡尺</p>					
E	一般公差:GENERAL TOLERANCE		更改說明:REV.DESCRPTION		更改說明:REV.DESCRPTION	
	尺寸範圍DIM		△		△	
	.0	±0.30	△		△	
	.00	±0.20	△		△	
	.000	±0.10	核准APPD	朱小华	2009-2-18	模型: 料號: ITEM NO
	文件編號		審核CHD	Tony	2009-2-18	
	SC-A-2500T		繪圖DWN	Liaozting	2009-2-18	
	比例: SCALE					規格: SPEC 2.50mm Crimp Style Connector

1

2

3

4

版本REV

繪制日期

A

2009-3-28

A

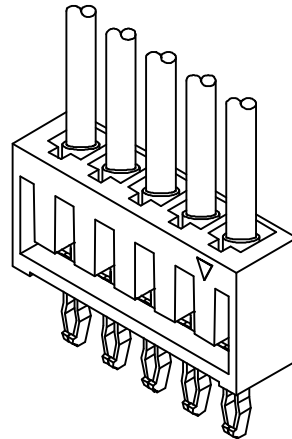
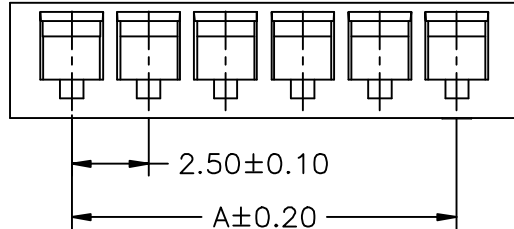

B

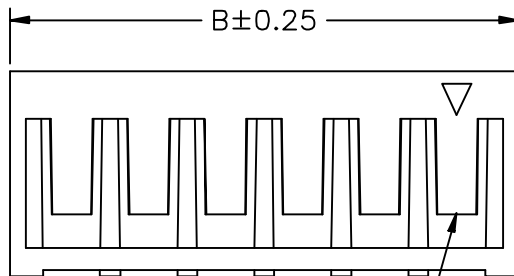

3.75±0.25

6.65±0.25

C

Circuit 1

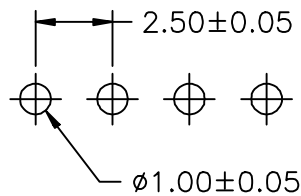

P.C.B. LAYOUT

PART NO.	Dimensions	
	A	B
02P	2.50	6.50
03P	5.00	9.00
04P	7.50	11.50
05P	10.00	14.00
06P	12.50	16.50
07P	15.00	19.00
08P	17.50	21.50
09P	20.00	24.00
10P	22.50	26.50
11P	25.00	29.00
12P	27.50	31.50
13P	30.00	34.00
14P	32.50	36.50
15P	35.00	39.00
16P	37.50	41.50

D

NOTE:

- Connector Type: V-Straight 180°
- Material: PA66 UL94V-0
- Row No.-Pin No.: NP-02P-16P

E

一般公差: GENERAL TOLERANCE

更改說明: REV. DESCRIPTION

更改說明: REV. DESCRIPTION

尺寸範圍DIM

①

④

10.01以上之尺寸

±0.20

②

⑤

10.00以內之尺寸

±0.15

③

⑥

孔位

±0.10

核准APPD

朱小华

2009-3-28

模型:

料號: ITEM NO

文件編號

審核CHD

Tony

2009-3-28

MODEL

B2512H00-V-NP

SC-EW-11

繪圖DWN

Liaozting

2009-3-28

比例: SCALE



SHIH CHUAN ELECTRONICS

規格: SPEC

2.50mm Crimp Style Connectors

1

2

3

4

版本REV

繪制日期

A

2009-3-28

A

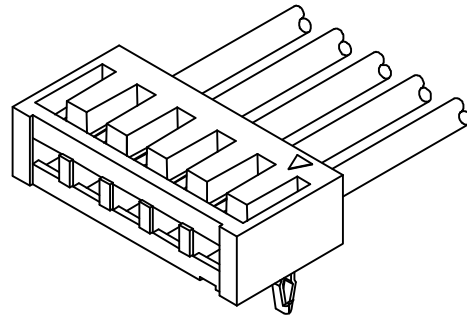
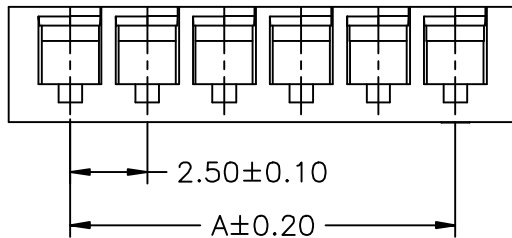

B

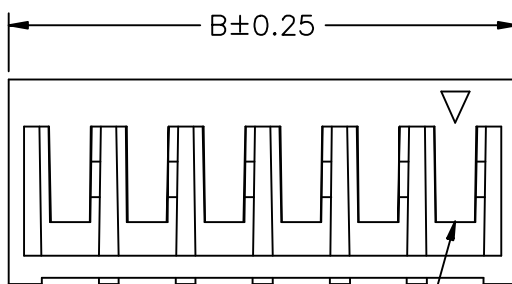

3.75±0.25

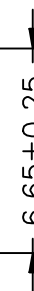

Circuit 1

C

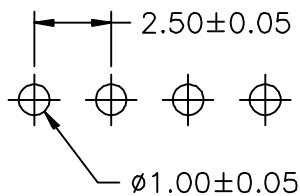

P.C.B LAYOUT

PART NO.	Dimensions	
	A	B
02P	2.50	6.50
03P	5.00	9.00
04P	7.50	11.50
05P	10.00	14.00
06P	12.50	16.50
07P	15.00	19.00
08P	17.50	21.50
09P	20.00	24.00
10P	22.50	26.50
11P	25.00	29.00
12P	27.50	31.50
13P	30.00	34.00
14P	32.50	36.50
15P	35.00	39.00
16P	37.50	41.50

D

NOTE:

- Connector Type: R-Right Angle 90°
- Material: PA66 UL94V-0
- Row No.-Pin No.: NP-02P-16P

E

一般公差: GENERAL TOLERANCE

更改說明: REV. DESCRIPTION

更改說明: REV. DESCRIPTION

尺寸範圍DIM



10.01以上之尺寸

±0.20



10.00以內之尺寸

±0.15



孔位

±0.10

核准APPD

朱小华

2009-3-28

模型:

料號: ITEM NO

文件編號

審核CHD

Tony

2009-3-28

MODEL

B2512H00-R-NP

SC-EW-11

繪圖DWN

Liaozting

2009-3-28

比例: SCALE



SHIH CHUAN ELECTRONICS

規格: SPEC

2.50mm Crimp Style Connectors